

S33

The reasonably priced
for individual requirements.

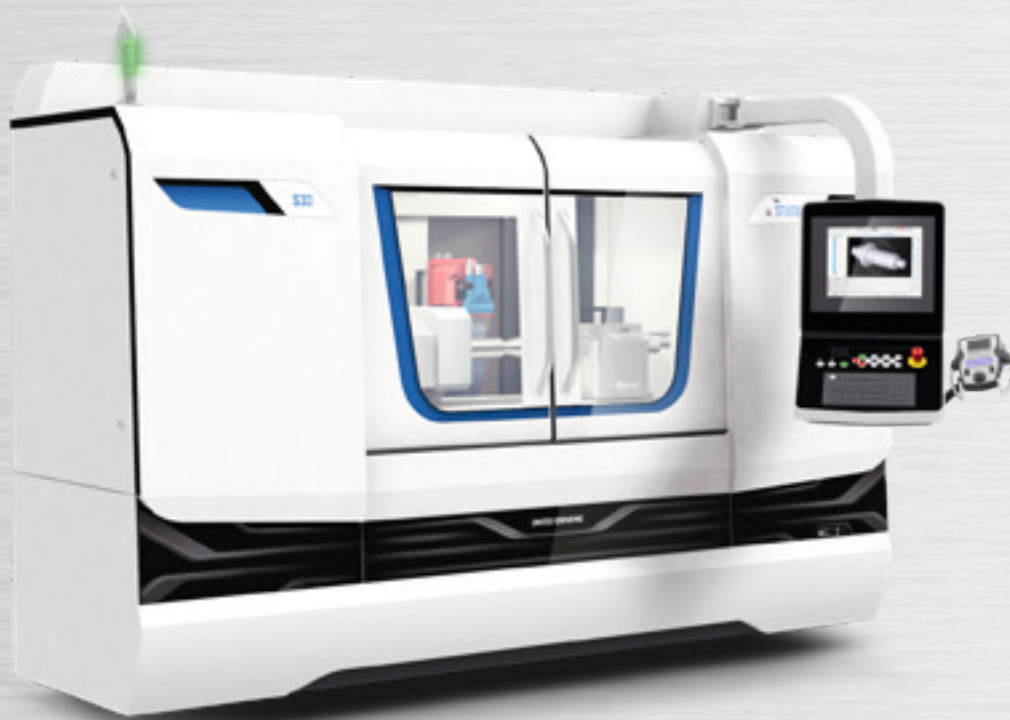

Key data

The S33 is a CNC universal cylindrical grinding machine for the individual, small-batch, and large-scale production of short to long-sized workpieces. It has distances between centers of 400 / 650 / 1000 / 1600 mm (15.7"/25.6"/39.4"/63") and a center height of 175 mm (6.9"). It can machine workpieces with a maximum weight of 150 kg (330 lbs).

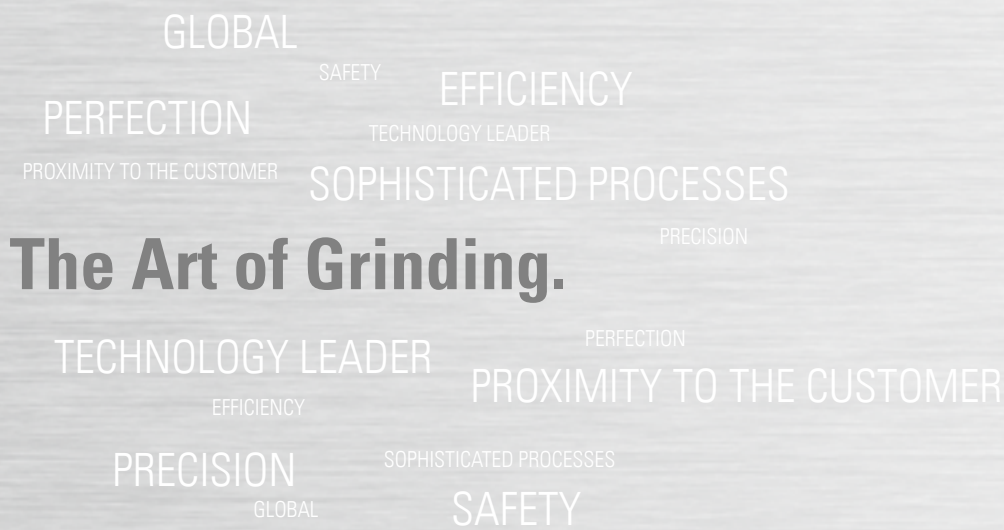

Fritz Studer AG

The name STUDER stands for more than 100 years of experience in the development and production of precision cylindrical grinding machines. "The Art of Grinding." is our passion, highest precision is our aim and top Swiss quality is our benchmark.

Our product line includes both standard machines, as well as complex system solutions in high-precision cylindrical grinding for machining small and medium-sized workpieces. In addition we offer software, system integration and a wide range of services. As well as receiving a complete tailor-made solution the customer also benefits from our 100 years of know-how in relation to the grinding process.

Our customers include companies from the machine tool industry, automotive, tool and die makers, the aerospace industry, pneumatics/hydraulics, electronics/electrical engineering, medical technology, the watch industry and job shops. They value maximum precision, safety, productivity and longevity. 24 000 manufactured and delivered systems make us the market leader and are clear evidence of our technological leadership in universal, external, internal and noncircular grinding. Around 800 employees, including 75 apprentices, make it their goal every day to ensure that "The Art of Grinding." will continue to be closely linked to the name STUDER in the future.

S33

If you don't know today what you'll be grinding tomorrow, then the S33 will impress you with its universality and flexibility: it can be retooled from grinding between centers to live spindle grinding in record time. You can grind even complex workpieces in a single clamping; this is made possible by the new wheelhead with two motor spindles. You also benefit from a wide range of wheelhead variants.

Characteristics

Dimensions

- Distance between centers 400 / 650 / 1000 / 1600 mm (15.7"/25.6"/39.4"/63")
- Centre height 175 mm (6.9")
- Max. workpiece weight 150 kg (330 lbs)

Hardware

- Optional wheelhead:
 - Turret wheelhead with up to 2 external grinding spindles and 1 internal grinding spindle. Automatic swiveling with 1 deg Hirth serration.
 - External wheelhead with grinding wheel right, 0 / 15 / 30 deg
- Turret wheelhead with frequency-controlled motor spindles for external and internal grinding
- C axis for the workhead, enabling form and thread grinding
- Tool table with integrated double T-slot for dressing devices
- Full enclosure with two sliding doors
- Granitan® S103 mineral-casting machine base



Software

- Very simple programming thanks to StuderPictogramming
- Reduced set-up and resetting times with STUDER Quick-Set
- Standardized interfaces for loader and peripheral devices
- Flexibly upgradeable with integrated software modules
- StuderWINprogramming software (optional) for creating grinding and dressing programs on an external PC



Customer value

- Turret wheelhead with frequency-controlled motor spindle
- Constant cutting speed is included in the standard package
- Two grinding wheels dia. 500 mm
- High-frequency internal grinding spindle

The CNC universal grinding machine for small budgets and high-demands.

From small to large workpieces. From single-part to series production. From distances between centers of 400 mm to 1600 mm (15.7" to 63"). The S33 is your flexible CNC universal cylindrical grinding machine.

Its foundation is a machine base made of solid Granitan® S103. The high-quality STUDER sub-assemblies guarantee you the highest precision, performance, and safety over many years. The full enclosure with large sliding doors enables easy access to the machine.

The STUDER grinding software turns all users into pros. Practical Studer-Pictogramming quickly and ideally exploits the machine's full potential. Save time! With StuderWINprogramming, grinding and dressing programs can be created efficiently offline.

By the way: we are certified throughout the value chain. The systematic development, manufacture, assembly and testing of all STUDER products are process-oriented and comply with the strict guidelines of VDA 6.4 and ISO 9001.

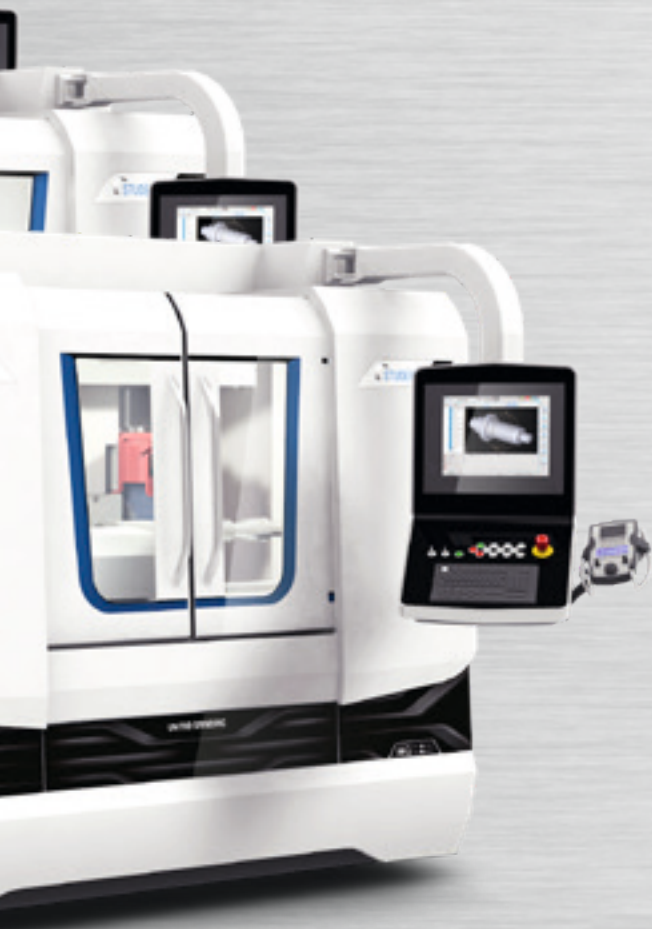

Granitan[®] S103 mineral-casting machine base

1

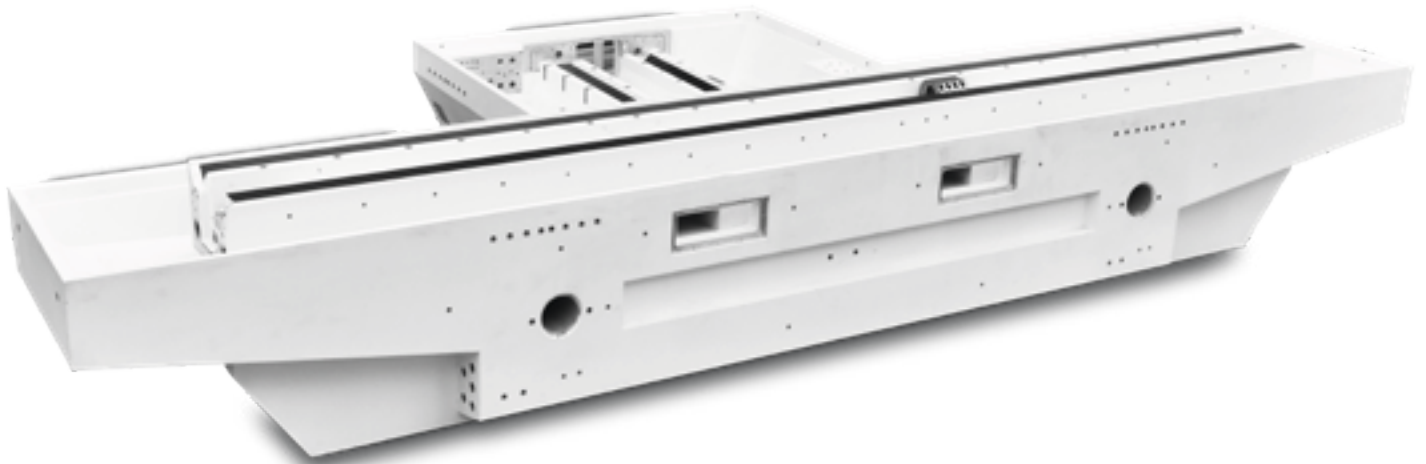

- Vibration-damping
- Wear-free
- Thermostable machine base thanks to an integrated cooling system
- Coolant tray integrated into the machine base

A good foundation is always the basis for success. That's why we use Granitan[®] S103 for our machine base. It's a mineral cast developed by STUDER that has proven itself over many years. What are the benefits of Granitan[®]? A high level of dimensional accuracy throughout the day. This is thanks to the excellent thermal properties of Granitan[®] and the flooding of the machine bed with coolant. Temporary temperature fluctuations are largely balanced out. The excellent damping properties of Granitan[®] ensure that an outstanding surface quality is achieved in the ground workpieces. Non-productive times also drop, as the grinding wheel's service life is increased.

The V and flat guideways for the longitudinal and cross slides are moulded directly into the machine base and are provided with a nonabrasive

2

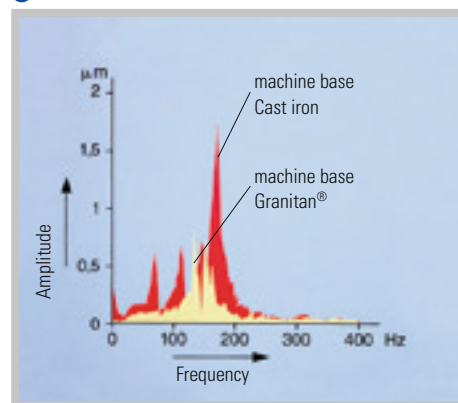

Granitan[®] S200 slideway coating. The patented knobbed structure of the guideways largely eliminates the slip-stick effect or floating of the slides observed on conventional guideways. The guideways offer the highest possible accuracy through the entire speed range with high load capacity and dampening levels. Thanks to the robust and maintenance-free design, these excellent guideway characteristics are more or less completely retained.

1 Machine base with X and Z guideways

2 Vibration behavior comparison of gray cast iron and Granitan[®] S103

Longitudinal and cross slides

1



2

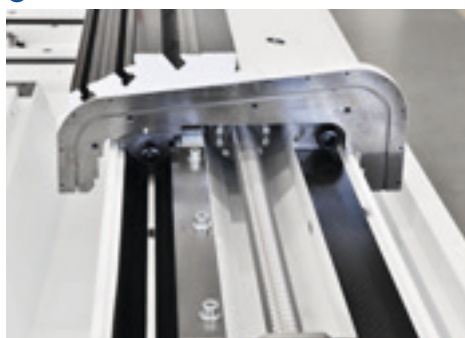

3

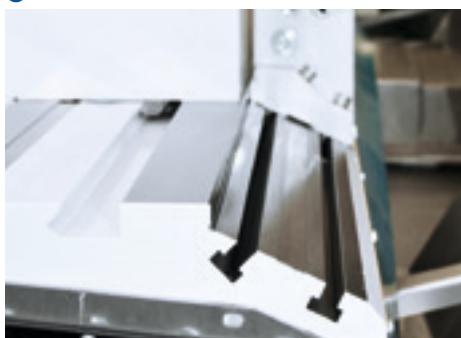

4



- High geometrical traverse precision
- Effective protection of guideways
- Auxiliary scale for setup and resetting

The longitudinal and cross slides are manufactured from high-quality gray cast iron and have highly precise, ground V and flat guideways. With the distance between the guideways optimally suited to the machine's overall rigidity. The slides rest completely on the guideways of the machine bed through the entire speed range. This provides the cornerstone for the excellent straightness of 0.003 mm (0.00012") over 1000 mm (40") measured length. The top of the longitudinal slide has a surface that is ground over its entire length and acts as a support for the workhead, the tailstock, as well as accessories and devices. A setup scale, recessed in

the table, makes it easy to set up and reset the units on the table. An additional T-slot enables the optimal utilization of dressing units. The slides are advanced by circulating ball screws connected to a three-phase servomotor via torsion-resistant, bellow couplings.

Wheelhead

1

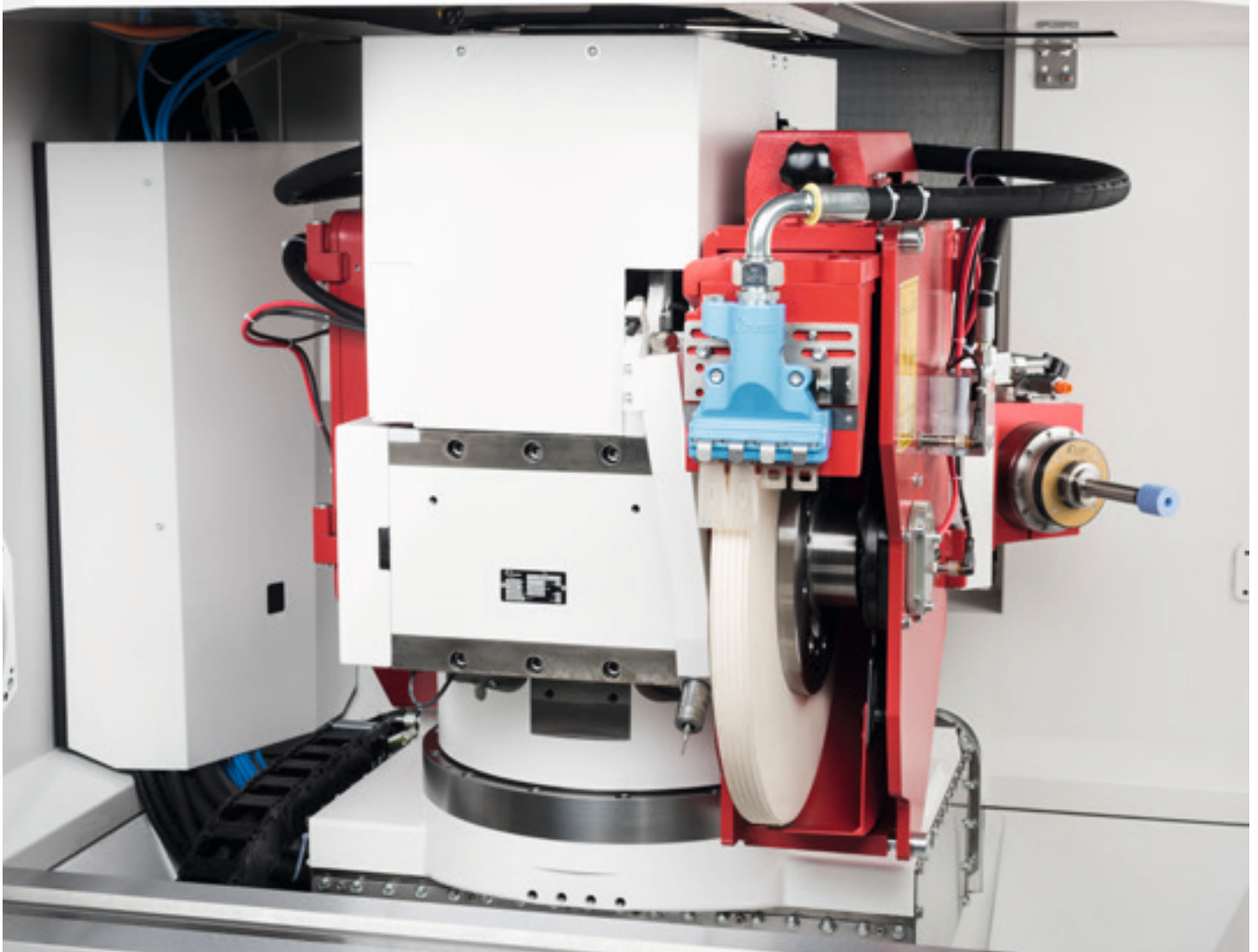

- Complete machining
- High output
- Cutting speed up to 50 m/s (9842 sfpm)

Two variants are available:

- Turret wheelhead with up to 2 external grinding spindles and 1 internal grinding spindle. Automatic swiveling with 1deg Hirth serration.
- External wheelhead with grinding wheel right, adjustable to 0 / 15 / 30 deg

Reduce set-up and resetting costs? You can do with this machine, especially in single-part or small-batch production. This is made possible by the turret wheelhead with several grinding wheels and Quick-Set for rapid set-up.

Boost efficiency with complete machining in a single clamping. The S33 handles internal, external, and face grinding with ease.

2

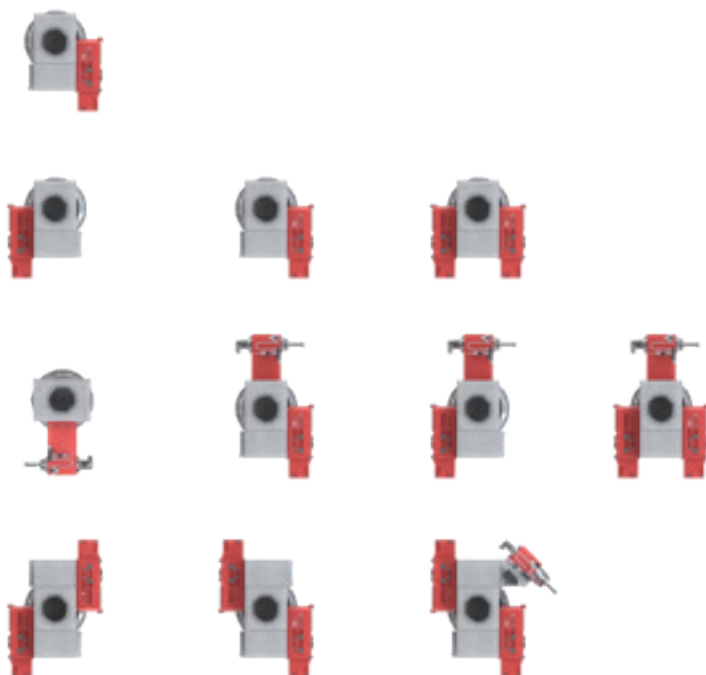

3

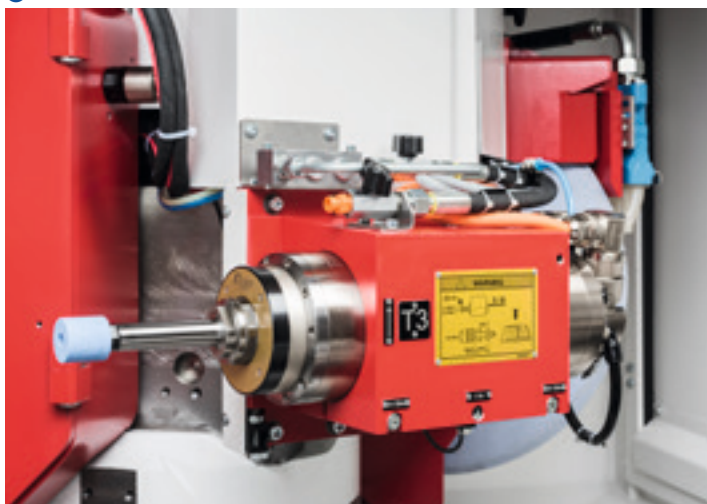

The swiveling wheelhead is equipped with water-cooled, roller-based, and maintenance-free motor spindles with stepless speed control and the latest generation of contact sensors. The shaft ends hold external wheelheads with a diameter of 500 mm (20") and a width of 63 (80 F5) mm (2.48" (3.15" F5)). For internal grinding, use powerful high-frequency spindles with 120 mm (4.72") external diameter. It's your choice: configure the wheelhead to match your specific needs.

-
- 2 Select wheelhead variants
 - 3 Internal grinding attachment

Workhead

1



- High roundness accuracy
- Low maintenance
- Air cushion

The versatile universal workhead enables both live spindle grinding and grinding between centres. The workhead is equipped with roller bearings, is low-maintenance and has an excellent roundness accuracy of under 0.0004 mm (0.000,016"), which can be optionally improved to under 0.0002 mm (0.000,008") during live spindle operations. The fine adjustment allows for taper corrections in the 1 µm (0.000,040") range during live spindle operations. Like the tailstock, the workhead is also equipped with a pneumatic lifting device to facilitate movement during setup and resetting.

The S33 can also be equipped with a chuck workhead specially designed for grinding chuck parts.

C axis for form and thread grinding

Grinding of shapes and threads is made possible by the position- and speed-controlled C axis. The C axis with an indirect measuring system on the drive motor is suitable for thread grinding and simple form grinding. For maximum form accuracy, a direct measuring system is mounted on the workhead spindle (high accuracy C-axis). With their high dynamic rigidity, the axis drives absorb the acceleration and grinding forces without any problem.

Tailstock

1



- Taper corrections
- Thermal stabilization by coolant flooding

The generously dimensioned barrel, designed for the use of Morse 3 or 4 taper centers, glides in the tailstock housing. The tailstock can be equipped with a hydraulically actuated barrel retraction for workpiece changeover. The center pressure can be easily fine-adjusted. The taper fine-adjustment allows corrections in the range below $1\ \mu\text{m}$ ($0.000,040''$) when grinding between centers. A high-precision result is guaranteed! An air cushion lift-off further facilitates simple movement during set-up and resetting.

In order to guarantee optimum thermal stability, the tailstock housing, barrel and the diamond holder are flooded with cooling lubricant. This guarantees ideal thermal stability. Clamping takes place with the help of a spring. This tailstock is suitable for workpiece weights up to 150 kg (330 lbs).

2



Synchronous tailstock

Use of the synchronous tailstock is particularly cost-effective when manufacturing part families, when grinding a workpiece over its entire length or if the use of a conventional driver is not possible.

Extra-fine grinding tailstock

Is the series production of hydraulic components your specialty? Then you will benefit from the extra-fine grinding tailstock with automatic cylindrical correction.

Control and programming

1



- PCU manual control unit
- EMC-tested control cabinet
- Ergonomically arranged controls

The S33 is equipped with a Fanuc 0i-TF. The controls are clearly and ergonomically arranged, making operation easy and efficient.

The portable control unit (PCU) facilitates set-up close to the grinding process. A special function - the electronic contact detection - makes it possible to keep non-productive times to a minimum.

The control cabinet is thermally separated and located on the left rear of the machine. The layout of the elements complies with the relevant safety norms and is EMC-tested.

2



StuderWIN

1



2

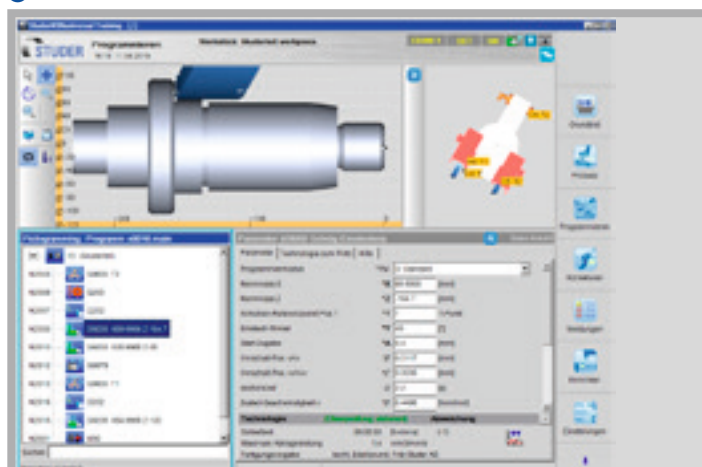

3

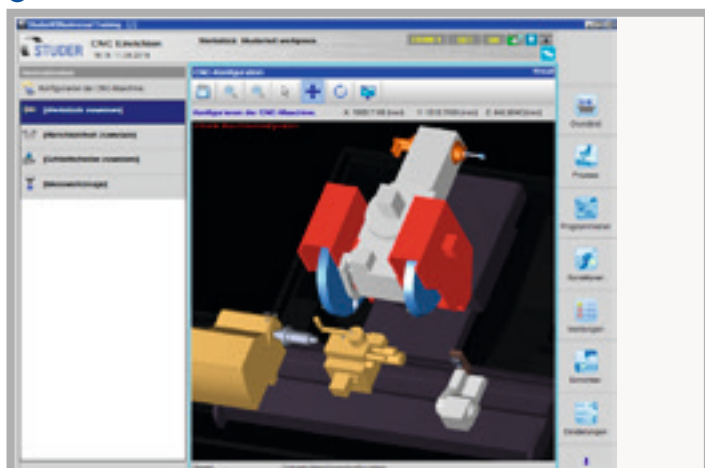

- Latest software technology
- StuderPictogramming
- Integrated peripheral equipment

Together with our users, STUDER has probably the greatest grinding expertise available anywhere in the world. We put all of our knowledge into our software solutions. Experience huge productivity gains with Studer-Technology. With just a few inputs, the technology computer automatically calculates the exact grinding parameters in just a few seconds. You will be amazed how precise you can grind with massively faster feed rates!

The StuderWIN user interface and the integrated software modules enable stable programming and efficient use of the machine. Standardized programming of the various systems enables the possibility of fully integrating the in-process measuring system and sensor technology for process monitoring.

More benefits with StuderWIN: import your workpiece drawing to visualize the grinding cycles. Or simply create your specific grinding wheel shapes on the basis of a workpiece imprint.

Expand the functionality of your machine with these optional integrated tools:

- StuderForm for form grinding and StuderThread for thread grinding, StuderContourBasic for contour grinding.
- Microfunctions: free programming of grinding and dressing process sequences for optimization of the grinding process.
- The functionality of StuderWIN can be extended even more thanks to various enhancements in the form of integrated software modules.

Do you prefer to program offline? Create your program on a PC using StuderWINprogramming, based on StuderWIN, and transfer it directly to the machine control unit.

- 1 StuderWIN
- 2 Workpiece programming
- 3 Assisted Setup

Process-optimized complete solutions guarantee greater efficiency and reliability throughout.



- Automatic production processes
- Integrated quality control
- Standard loader – interfaces

Several loading systems are available for the S33. You can choose between a standard or customized solution, which thanks to its modularity can be modified to match the exact usage of the machine and the machining processes. Seamlessly integrate your desired peripherals into the production process. The automation systems communicate with the machine via the standardized loader interface. This allows even complex handling tasks to be carried out. Comprehensive quality control is possible during the grinding process. This entails: in-process, post-process, recording, evaluation and correction. This type of quality assurance is crucial during grinding, and especially during match grinding.



Customer care

STUDER cylindrical grinding machines should fulfil the customer's requirements for as long as possible, work efficiently, function reliably and be available at all times. From «start up» through to «retrofit» – our Customer Care is there for you throughout the working life of your machine. 30 professional helplines and more than 60 service technicians are available in your area, wherever you are in the world.

- We will provide you with fast, uncomplicated support.
- We will help to increase your productivity.
- We work professionally, reliably and transparently.
- We will provide a professional solution to your problems.



Start up

Commissioning
Warranty extension



Qualification

Training
Product support



Prevention

Maintenance
Inspection



Service

Customer service
Customer consultation
HelpLine



Digital Solutions™

Remote service
Service monitor
Production monitor

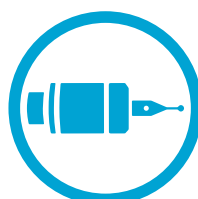

Material

Spare parts
Replacement parts
Accessories



Rebuild

Machine overhaul
Assembly overhaul



Retrofit

Modifications
Retrofits

Technical specifications

Main Dimensions

Distance between centres	400 / 650 / 1000 / 1600 mm (15.7"/25.6"/39.4"/63")
Centre height:	175 mm (6.9")
Max. workpiece weight between centres	150 kg (330 lbs)

Cross slide: X axis

Max. travel	370 mm (14.6")
Speed	0,001 – 15 000 mm / min (0.000,04 – 590 ipm)
Resolution	0,00001 mm (0.000,000,4")

Longitudinal slide: Z axis

Max. travel	500 / 800 / 1150 / 1750 mm (19.7"/31.5"/45.3"/68.9")
Speed	0,001 – 20 000 mm / min (0.000,04 – 787 ipm)
Resolution	0,00001 mm (0.000,000,4")

Wheelhead

	Type: external	Type: universal
Swiveling range	0 / 15 / 30 deg	-30 to +210 deg
Resolution		1 deg Hirth
Fitting taper	dia. 73 mm (2.87")	dia. 73 mm (2.87")
Drive power	7,5 kW (10 hp)	7,5 kW (10 hp)
Grinding wheel, Ø×width×bore	500×63 (80F5)×203 mm (20"×2.5" (3.15"F5)×8")	500×63 (80F5)×203 mm (20"×2.5" (3.15"F5)×8")
Circumferential speed	up to 50 m / s (9840 sfpm)	up to 50 m / s (9840 sfpm)
Internal grinding attachment for high frequency spindles		
Spindle dia.		dia. 120 mm (4.73")
Speeds		24 000 – 120 000 rpm

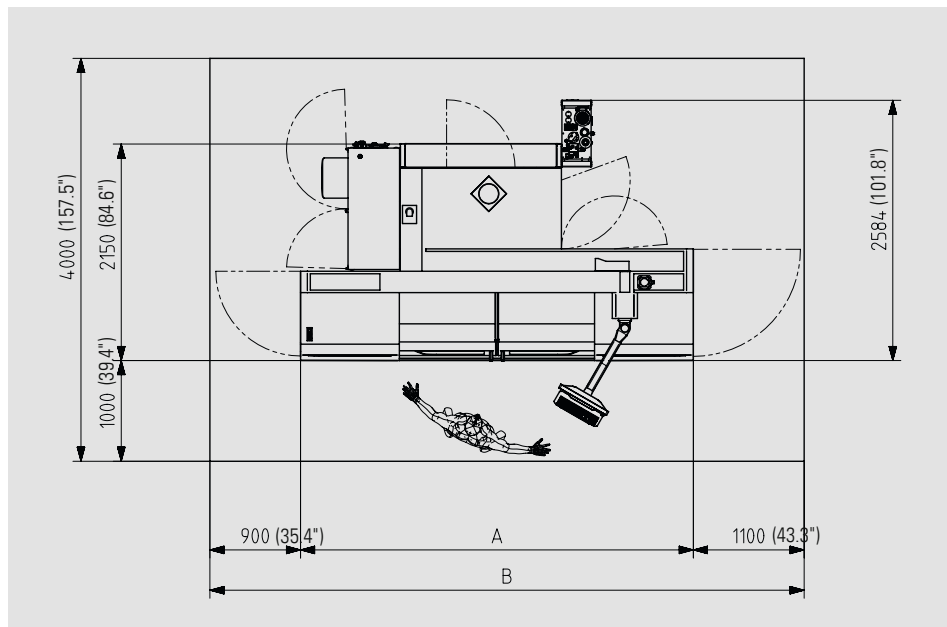

	A	B
Distance between centers 400 (15.7")	2200 (86.6")	4500 (177")
Distance between centers 650 (25.6")	3200 (126")	5200 (205")
Distance between centers 1000 (39.4")	3900 (153.5")	5900 (232")
Distance between centers 1600 (63")	5100 (201")	7100 (280")

Universal workhead

Speed range	1 – 1500 rpm	1 – 1500 rpm
Fitting taper	MT4 / dia. 70 mm (2.7")	MT5
Spindle feedthrough	dia. 26 mm (1.02")	dia. 30 mm (1.18")
Driving power:	3 kW (4 hp)	3 kW (4 hp)
Load during live grinding	70 Nm (52 ft lbs)	70 Nm (52 ft lbs)
Roundness accuracy during live grinding	0,0004 mm (0.000,016") (Option: 0,0002mm / 0.000,008")	0,0004 mm (0.000,016") (Option: 0,0002mm / 0.000,008")
Speed range	1-1000 rpm	1-1000 rpm
Fitting taper	MT5 / dia. 110 mm (4.3")	ISO50 / dia. 110 mm (4.3")
Spindle feedthrough	dia. 38 mm (1.5")	dia. 50 mm (1.97")
Driving power:	4 kW (5.4 hp)	4 kW (5.4 hp)
Load during live grinding	180 Nm (134 ft lbs)	180 Nm (134 ft lbs)
Roundness accuracy during live grinding	0,0004 mm (0.000,016") (Option: 0,0002mm / 0.000,008")	0,0004 mm (0.000,016") (Option: 0,0002mm / 0.000,008")

Option

C axis standard, indirect measuring system	0,0001 deg	0,0001 deg	0,0001 deg
--	------------	------------	------------

Chuck workhead

Speed range	1 – 1500 rpm	1 – 1000 rpm	1 – 1000 rpm
Fitting taper	MT4 / dia. 70 mm (2.7")	MT5 / dia. 110 mm (4.3")	ISO50 / dia. 110 mm (4.3")
Spindle feedthrough	dia. 26 mm (1.02")	dia. 38 mm (1.5")	dia. 50 mm (1.97")
Driving power:	3 kW (4 hp)	4 kW (5.4 hp)	4 kW (5.4 hp)
Load during live grinding	100 Nm (74 ft lbs)	250 Nm (186 ft lbs)	250 Nm (186 ft lbs)
Roundness during live spindle grinding	0,0004 mm (0.000,016") (Option: 0,0002mm / 0.000,008")	0,0004 mm (0.000,016") (Option: 0,0002mm / 0.000,008")	0,0004 mm (0.000,016") (Option: 0,0002mm / 0.000,008")

Option

C axis standard, indirect measuring system	0,0001 deg	0,0001 deg	0,0001 deg
C axis high-precision, direct measuring system	0,0001 deg	0,0001 deg	0,0001 deg

Tailstock

Fitting taper	MT3	MT4
Travel of barrel	35 mm (1.37")	60 mm (2.36")
Diameter of barrel	50 mm (1.97")	60 mm (2.36")
Fine adjustment for cylindricity corrections	±40 µm (0.0016")	±80 µm (0.0032")

Synchronous tailstock

Fitting taper	MT4
Travel of barrel	90 mm (3.54")
spindle nose	dia. 70 mm (2.75")
Workpiece weight between centres	50 kg (110 lbs)
Fine adjustment for cylindricity corrections	±80 µm (0.0032")

Extra-fine grinding tailstock

Fitting taper	MT3
Barrel stroke	35 mm (1.37")
Diameter of barrel	50 mm (1.97")
Automatic fine adjustment for cylindricity corrections	±40 µm (0.0016")

Control unit

Fanuc Oi –TF

Guaranteed working precision

Surface straightness	
Measuring length 400 mm	0,0020 mm (0.000,08")
Measuring length 650 mm (25.6")	0,0025 mm (0.000,10")
Measuring length 1 000 mm (39.4")	0,0030 mm (0.000,12")
Measuring length 1600 mm	0,0040 mm (0.000,16")

Connected load

Total connected load	20 kVA
Air pressure	5,5-7 bar (80-102 psi)

Total weight

Center distance 400mm	8500 kg (18 700 lbs)
Distance between centres 650 mm (25.6")	9500 kg (20 900 lbs)
Distance between centres 1 000 mm (39.4")	10 500 kg (23 150 lbs)
Center distance 1600mm	12 000 kg (26 500 lbs)

The information given is based on the technical levels of our machine at the time of this brochure going to print. We reserve the right to further develop our machines technically and make design modifications. This means that the dimensions, weights, colours, etc. of the machines supplied can differ. The diverse application possibilities of our machines depend on the technical equipment

specifically requested by our customers. The equipment specifically agreed with the customer is therefore exclusively definitive for the equipping of the machines, and not any general data, information or illustrations.



Fritz Studer AG
3602 Thun
Switzerland
Phone +41 33 439 11 11
Fax +41 33 439 11 12
info@studer.com
www.studer.com



ISO 9001
VDA6.4
certified

